



DV905 Rym

Finiture cromatiche / Colour finishes

Tavoli/Tables

Piani di lavoro sp. 5 cm, in laminatino/Worktops 5 cm thick, in low pressure laminate



Piani di lavoro sp. 5 cm, in laminatino Fenix/Worktops 5 cm thick, in low pressure Fenix laminate

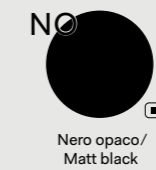

Piani di lavoro sp. 5 cm, in impiallacciato/Worktop 5 cm thick, veneered

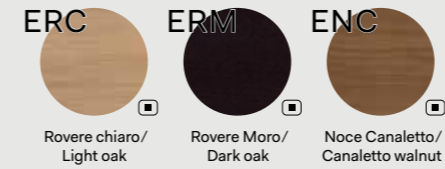

Piani di lavoro sp. 5 cm, in cuoio con cuciture/Worktop 5 cm thick, in leather with stitches



Piani di lavoro sp. 0.5 cm, in vetro retrolaccato / Worktops 0.5 cm thick, rear-lacquered glass



Piani di lavoro sp. 0.5 cm, in vetro temprato retrolaccato acidato con bordi perimetrali lavorati a filo lucido / Worktops 0.5 cm thick, rear-lacquered and acetated tempered glass with outer polished edges

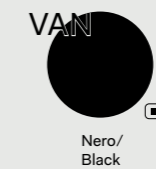

Strutture metalliche/Metal structures

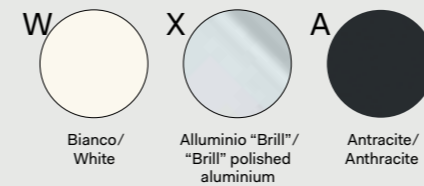

Mobili di servizio/Service units

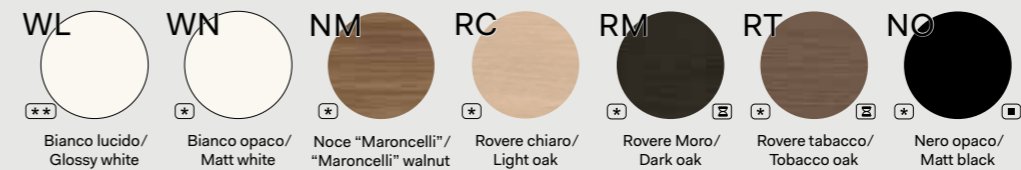

Scocca, ripiani sp. 2.5 cm e ante sp. 1.8 cm, in impiallacciato / Body, shelves 2.5 cm and doors 1.8 cm thick, veneered

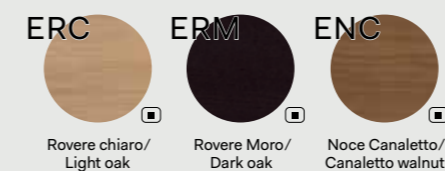

Note

- ☐ Prodotti non in pronta consegna. Per la disponibilità contattare l'ufficio commerciale/Items not in prompt delivery. Please contact the commercial department to check availability.
- ☒ Fino ad esaurimento/Until exhaustion.

DV905 Rym

Tavoli scrivania/Desks

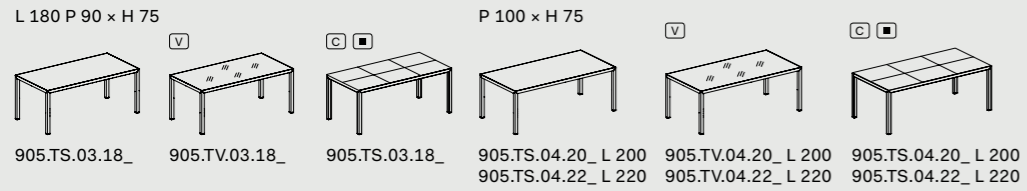

Tavoli per integrazione con mobili di servizio /Desk for integration with service units

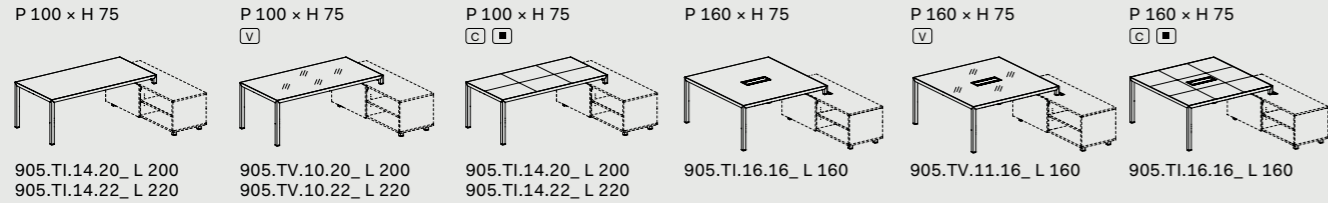

Mobili di servizio e cassetteria interna /Service units and internal pedestal

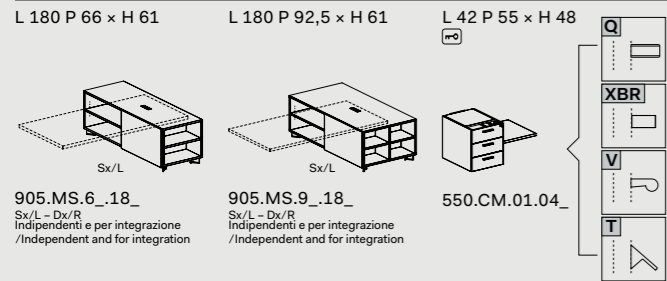

Modesty panels

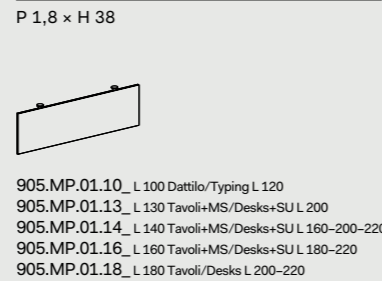

Modesty Panel in cuoio /Leather Modesty Panel

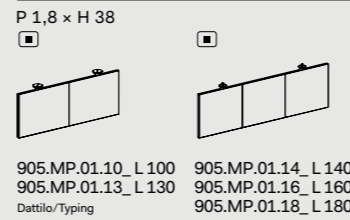

Tavoli scrivania L 200 x P 100 con mobile di servizio L 180 x P 66/Desks W 200 x D 100 with service unit W 180 x D 66

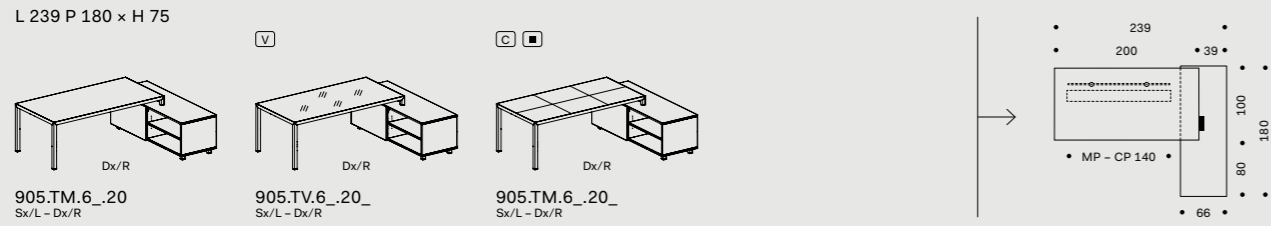

Tavoli scrivania L 220 x P 100 con mobile di servizio L 180 x P 66/Desks W 220 x D 100 with service unit W 180 x D 66

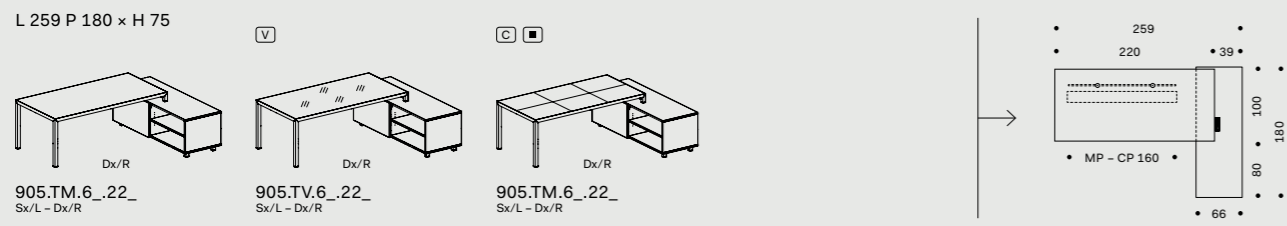

Tavoli scrivania L 200 x P 100 con mobile di servizio L 180 x P 92,5/Desks W 200 x D 100 with service unit W 180 x D 92,5

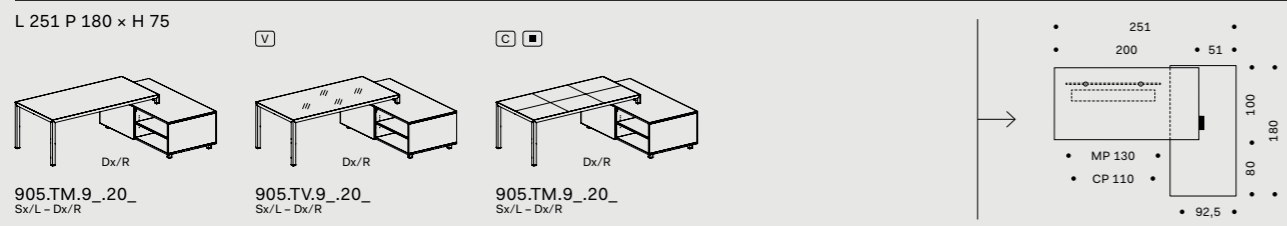

Note:

1 Le finiture impiallacciate e cuoio non sono in pronta consegna. Per la disponibilità contattare l'ufficio commerciale /Veneered and leather finishes are not in prompt delivery. Please contact the commercial department to check availability;

2 Per la scelta dei contenitori e degli accessori vari, consultare il relativo listino o catalogo/To choose storage units and accessories, please check correspondent price list or catalogue;

3 I tavoli possono essere montati sui mobili di servizio P 66 e P 92,5 cm (destri o sinistri). Per ogni soluzione compositiva è disponibile a listino la dimensione del corrispondente modesty panel (vedi relativa quota indicata con MP) e del corrispondente canale passacavi (vedi relativa quota indicata con CP)/The desks can be fixed on the service units depth 66 and depth 92,5 cm (right or left hand). To order the modesty panel please check the dimensions marked with MP and the dimensions marked with CP for the relevant cables channel;

Dati tecnici / Technical data

Tavoli e allunghi dattilo /Typing and extension tables

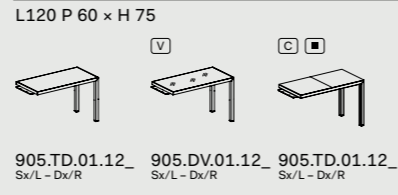

DV905 Rym

Tavoli scrivania L 220 x P 100 con mobile di servizio L 180 x P 92,5/Desks W 220 x D 100 with service unit W 180 x D 92,5

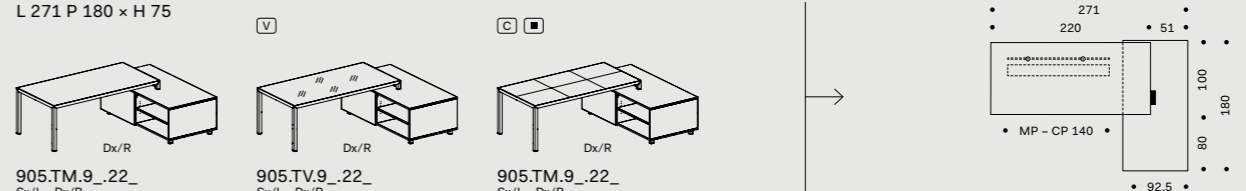

Tavoli scrivania L 160 x P 160 con mobile di servizio L 180 x P 66/Desks W 160 x D 160 with service unit W 180 x D 66

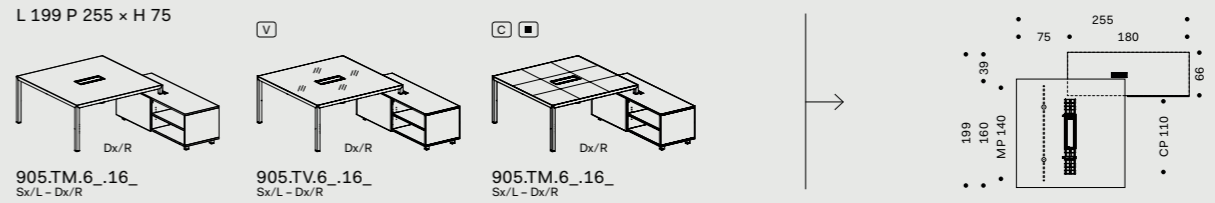

Tavoli scrivania L 160 x P 160 con mobile di servizio L 180 x P 92,5 /Desks W 160 x D 160 with service unit W 180 x D 92,5

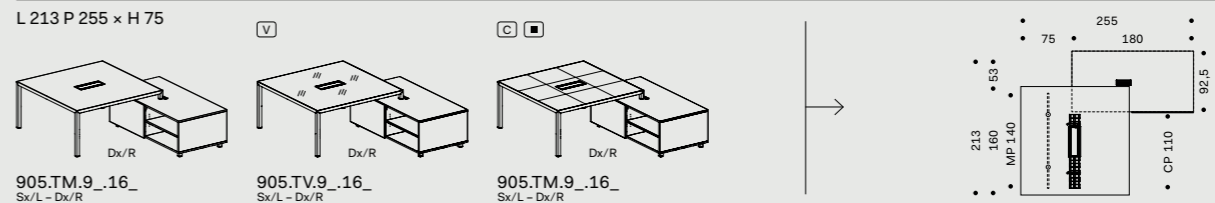

Tavoli riunione/Meeting tables

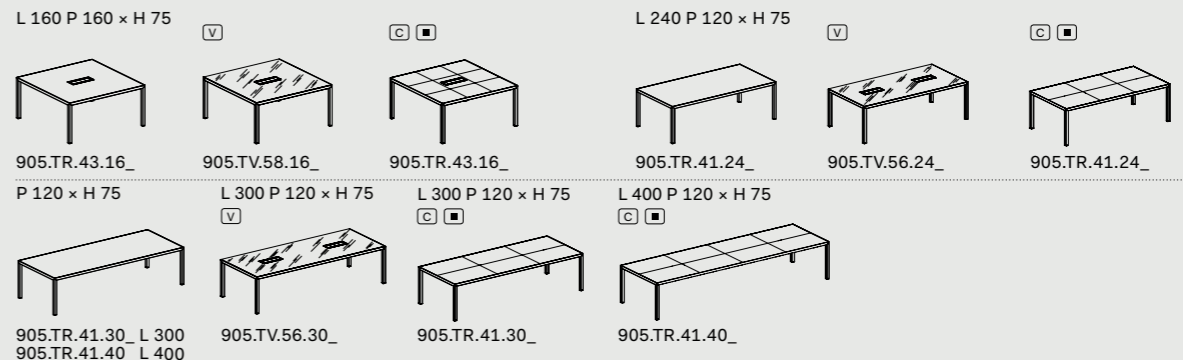

Cassettiere su ruote/Pedestals on castors

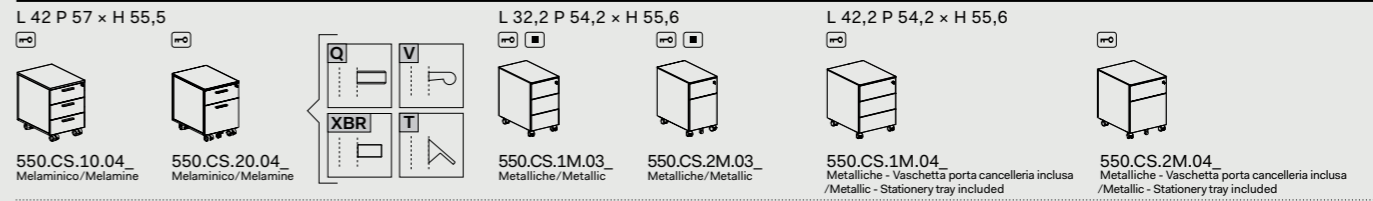

Note: La finitura impiallacciato non è in pronta consegna. Per la disponibilità contattare l'ufficio commerciale. Per portacassetteria cassetti, vedi capitolo DV300-Accessori /Veneered finishes is not in prompt delivery. Please contact the commercial department to check availability. For stationary tray, see chapter DV300-Accessories.

Accessori per canalizzazione - Elettificazione - Vari/Accessories for wire management - Electrification - Various

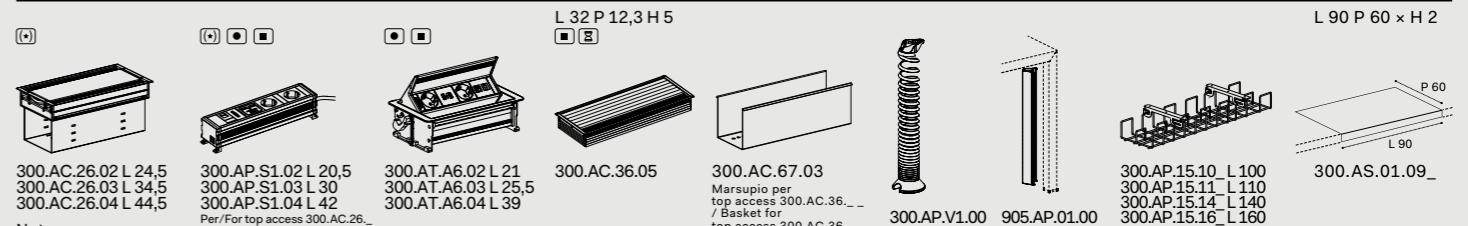

Note:

4 Le dimensioni sono espresse in cm - consultare il listino prezzi per le caratteristiche tecniche, i codici degli articoli e delle finiture/Dimensions are stated in cm - for technical characteristics, article code numbers and finishing see price list;

5 Prodotti non in pronta consegna. Per la disponibilità contattare l'ufficio commerciale/Items not in prompt delivery. Please contact the commercial department to check availability;

6 Articoli prodotti solo su richiesta/Items produced; only on demand;

7 Con serratura/With lock; 8 Vetro/Glass;

9 Cuoio/Leather.

Dati tecnici / Technical data