

Tavoli/Tables

Piani di lavoro sp. 3.8 cm, in melaminico con bordi in ABS sp. 0.2 cm / Worktops 3.8 cm thick, in melamine with ABS edge-profiles 0.2 cm thick

Piano di lavoro effetto pelle sp. 3.8 cm (per tavoli P. 90 cm, tavoli sagomati e tavoli riunione - esclusi tavoli riunione rotondi) / Leather effect worktop 3.8 cm thick (for desk D.90 cm, shaped desks and meeting tables - round meeting tables are not included)

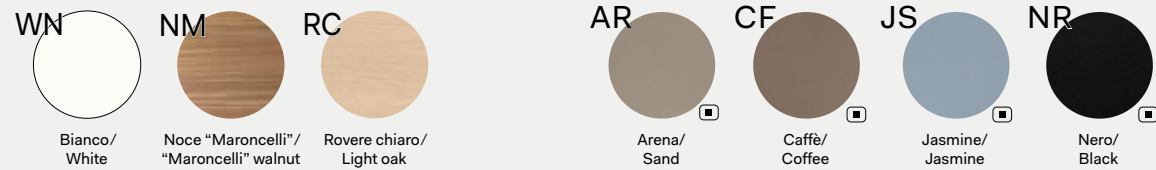

Modesty panel

Sp. 1.8 cm, in melaminico/18 mm thick, in melamine

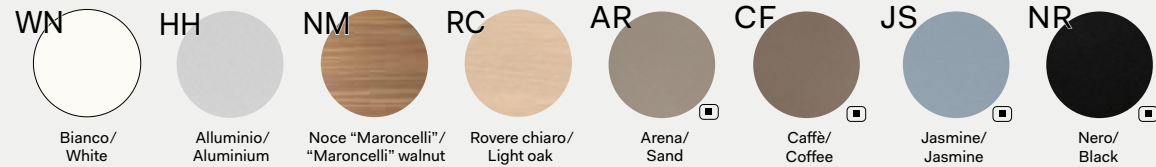

Gambe metalliche/Metal legs

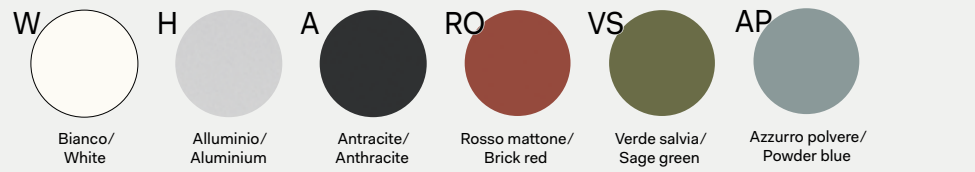

Carter chiuso e aperto / Casing closed and open



Mobili di servizio/Service units

Scocca e ripiani sp. 1.8 cm, in melaminico/ Bodies and shelves 1.8 cm thick, in melamine

Ante scorrevoli sp. 1.8 cm, in melaminico con bordo ABS sp. 0.15 cm colore alluminio/ Sliding doors 1.8 cm thick, in melamine with aluminium-coloured ABS edge-profiles 0.15 cm thick

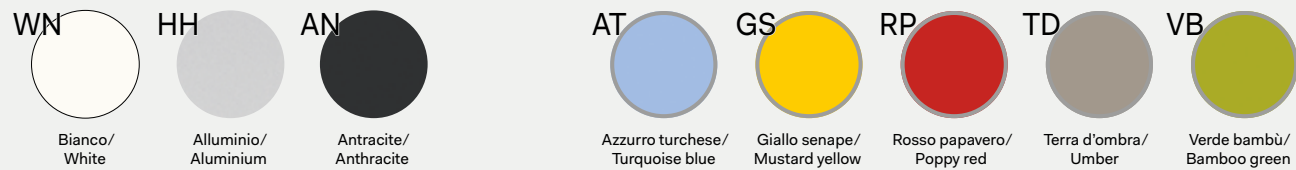

Ante scorrevoli sp. 1.8 cm, in melaminico con bordo ABS sp. 0.15 cm in tinta/Sliding doors 1.8 cm thick, in melamine with ABS edge-profiles 0.15 cm thick, in same color



Note

Per i colori e le finiture dei Frontal Panels, vedere il relativo capitolo in DV300 - Accessori. / For colours and finishes of Frontal Panels, see the chapter in DV300 - Accessories.
 ■ Prodotti non in pronta consegna. Per la disponibilità contattare l'ufficio commerciale./Items not in prompt delivery. Please contact the commercial department to check availability.

Piani di lavoro in melaminico sp. 38 mm con bordi perimetrali in ABS/Worktops in melamine 1 1/2" thick with perimetrical edges in ABS

Tavoli scrivanie/Desks

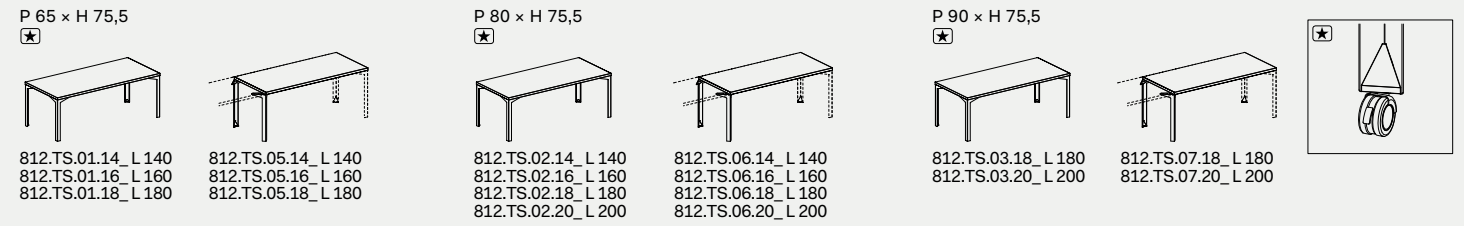

Tavoli alti H 107 / Standing tables H 107

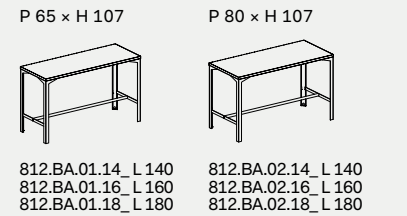

Tavoli scrivania sagomati / Shaped desks

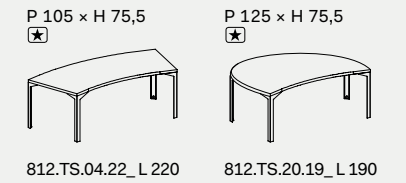

Allunghi laterali / Lateral extensions



Cassettiere portanti/Carrying pedestals

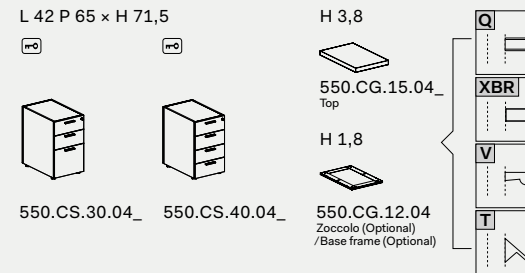

Contenitori H 75,5/Storage units H 75,5

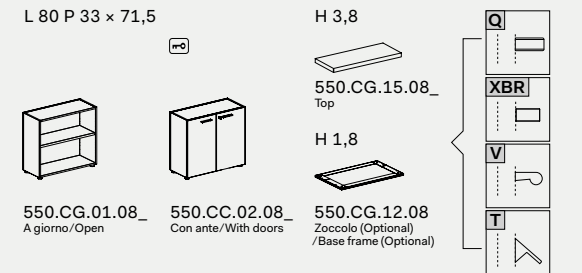

Tavoli a 2 scrivanie contrapposte/Benches

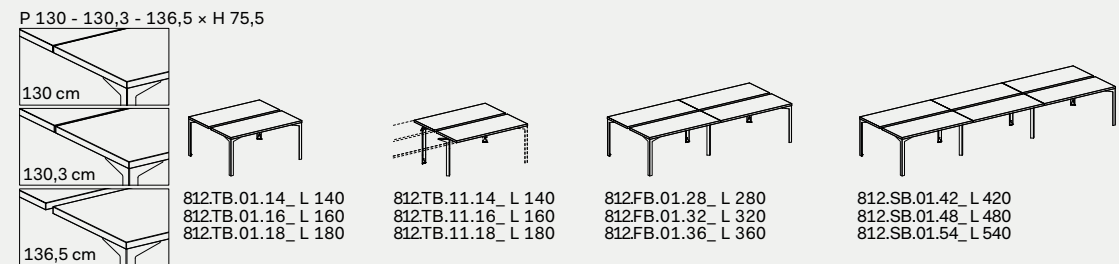

Tavoli a 2 scrivanie contrapposte + binario centrale / Benches + central rail

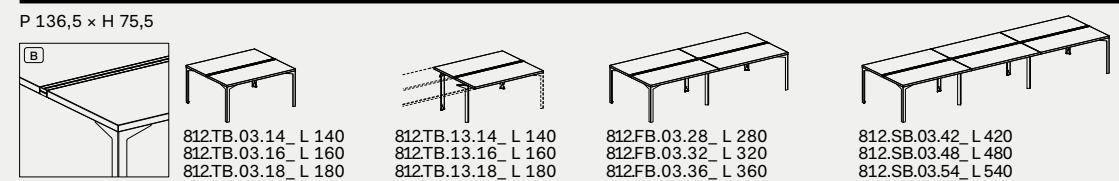

Tavoli scrivania con asole e 2 top access/Desks with opening and 2 top access

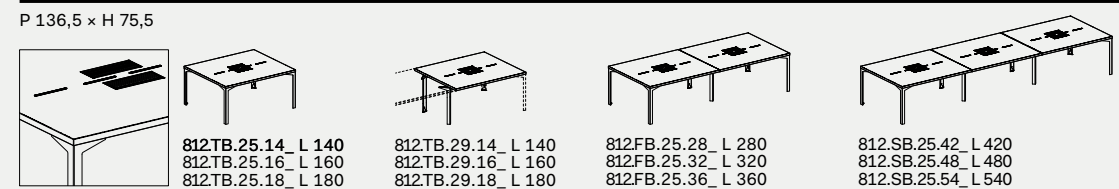

Note:

1 Le dimensioni sono espresse in cm - consultare il listino prezzi per le caratteristiche tecniche, i codici degli articoli e delle finiture/Dimensions are stated in cm - for technical characteristics, article code numbers and finishing see price list;
 B Con binario centrale/With central rail;
 S Con serratura/With lock;
 * I tavoli sono disponibili anche nella versione su ruote, consultare il listino per le varianti; /Tables are also available on wheels, see price list;

Piani di lavoro in melaminico sp. 38 mm con bordi perimetrali in ABS/Worktops in melamine 1 1/2" thick with perimetrical edges in ABS

Tavoli a 2 scrivanie contrapposte/Benches

P 160 - 160,3 - 166,5 x H 75,5

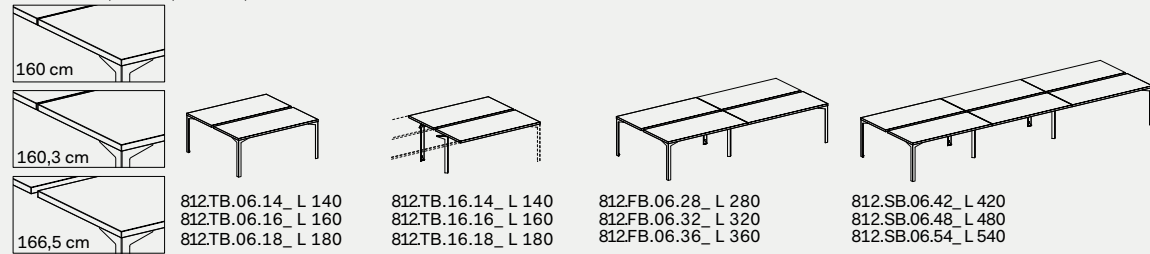

Tavoli a 2 scrivanie contrapposte + binario centrale/Benches + central rail

P 166,5 x H 75,5

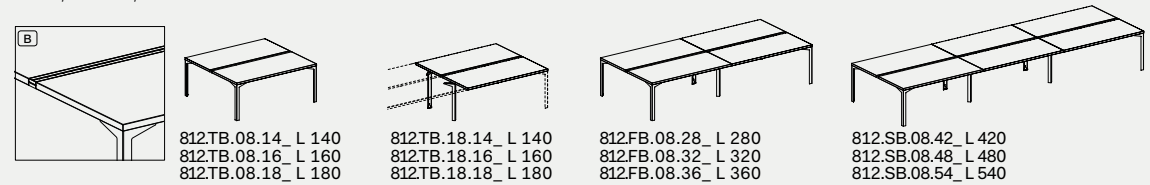

Tavoli scrivania per integrazioni /Integrable desks

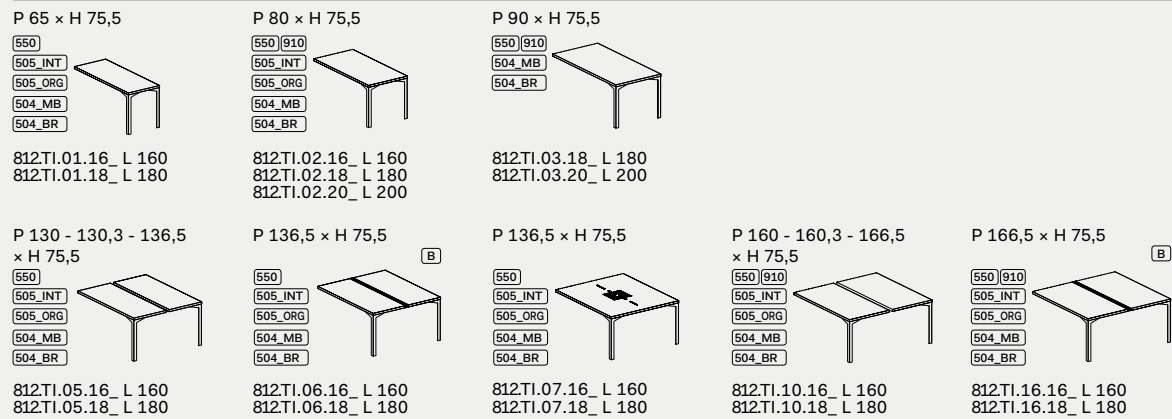

Note: Kit staffe da ordinare a parte, in base alla composizione da sviluppare / Brackets kit to be ordered separately, based on the composition to be developed

Tavoli sagomati integrabili su mobili di servizio/Integrable shaped desks for service units

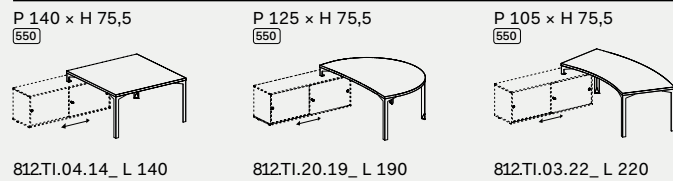

Note: Kit staffe per integrazione al mobile di servizio compreso nel codice / Brackets kit for integration to the service unit included in the code

Mobili di servizio con ante scorrevoli/Service units with sliding doors

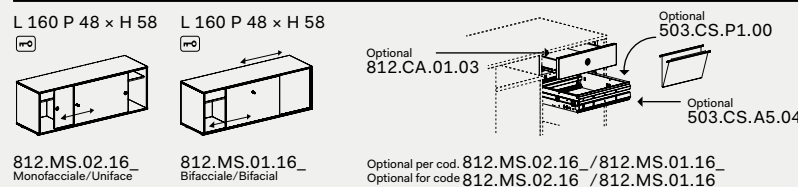

Kit supporto per fissaggio tavoli su mobile di servizio / Desk tables integration on service unit support kit

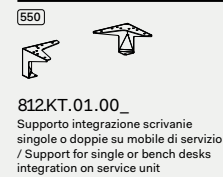

Note: [L] Con serratura/With lock; [B] Con binario centrale/With central rail; [550] Fissaggio su mobile di servizio / Service unit hooking; [910] Fissaggio su mobile multiuso DV910 / DV910 multipurpose unit hooking; [505_INT] Fissaggio su contenitori DV505 / DV505 storage unit hooking; [505_ORG] Fissaggio su orgatower DV505 / DV505 orgatower unit hooking; [504_MB] Fissaggio su moduli base DV504 / DV504 base modules hooking; [504_BR] Fissaggio su barra DV504 / DV504 metal bar hooking;

Piani di lavoro in melaminico sp. 38 mm con bordi perimetrali in ABS/Worktops in melamine 1 1/2" thick with perimetrical edges in ABS

Composizioni con tavoli integrabili su mobili di servizio/Compositions with integrable desks for service units [550]

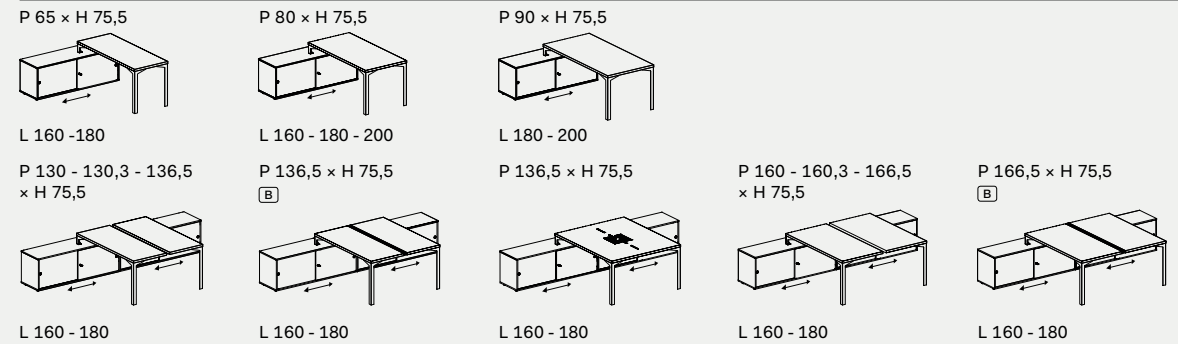

Note: Per le composizioni con tavoli scrivania su mobili di servizio ordinare sempre il kit Cod. 812.KT.01.00, il tavolo integrabile scelto e il mobile di servizio / For compositions with desk tables on service unit, always order the kit Cod. 812.KT.01.00, the chosen integrable table and the service unit

Kit supporto per fissaggio tavoli su mobile multifunzione DV910 / Desk tables integration on DV910 multi-purpose storage unit

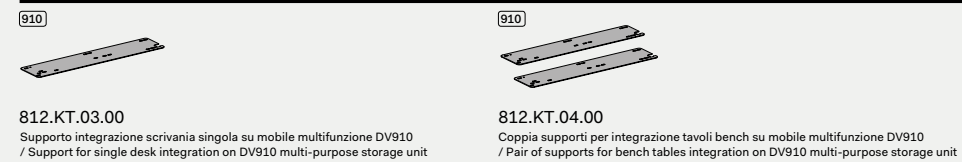

Composizioni con tavoli integrabili a mobile multifunzione DV910/Compositions with integrable desks on DV910 multi-purpose storage unit [910]

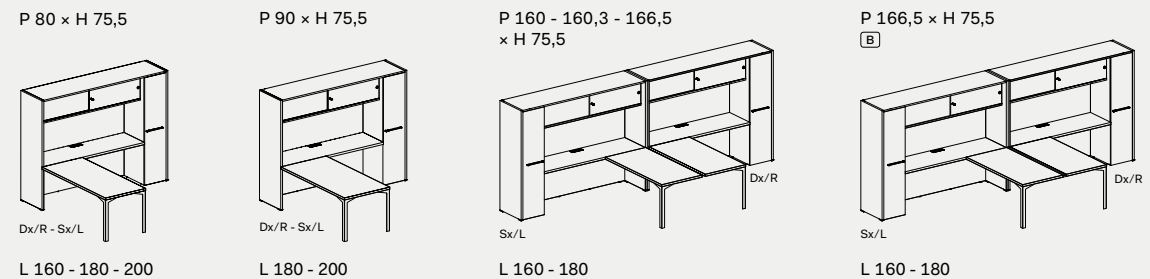

Note: Ordinare sempre il kit Cod. 812.KT.03.00 per i tavoli singoli e il kit Cod. 812.KT.04.00 per i tavoli bench / Always order the kit Cod. 812.KT.03.00 for single desk tables and the kit Cod. 812.KT.04.00 for bench tables. Ordinare a parte il mobile multifunzione e relativi accessori, consultare il listino DV910/Order the multifunctional storage unit and related accessories separately, see the DV910 price list

Kit supporto per fissaggio tavoli su contenitori integrati DV505 H= 75,5, 116,5, 166 / Desk tables on integrated storage unit DV505 H= 75,5, 116,5, 166



Composizioni con tavoli integrabili a contenitori DV505 H= 75,5, 116,5, 166 [505_INT] / Compositions with integrable desks on storage unit DV505 H= 75,5, 116,5, 166

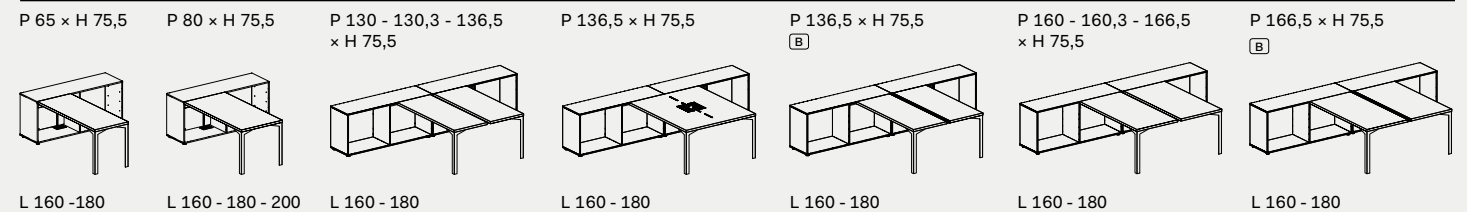

Note: Ordinare sempre il kit Cod. 812.KT.05.00 per i tavoli singoli e il kit Cod. 812.KT.06.00 per i tavoli bench / Always order the kit Cod. 812.KT.05.00 for single desk tables and the kit Cod. 812.KT.06.00 for bench tables. Ordinare a parte i moduli contenitori integrati H 75,5, 116,5, 166 e relativi accessori, consultare il listino DV505/Order the H = 75,5 - 116,5 - 166 integrated storage unit and related accessories separately, see DV505 price list

Note: [L] Le dimensioni sono espresse in cm - consultare il listino prezzi per le caratteristiche tecniche, i codici degli articoli e delle finiture/Dimensions are stated in cm - for technical characteristics, article code numbers and finishing see price list; [B] Con binario centrale/With central rail; [550] Fissaggio su mobile di servizio / Service unit hooking; [910] Fissaggio su mobile multiuso DV910 / DV910 multipurpose unit hooking; [505_INT] Fissaggio su contenitori DV505 / DV505 storage unit hooking;

Piani di lavoro in melaminico sp. 38 mm con bordi perimetrali in ABS/Worktops in melamine 1 1/2" thick with perimetrical edges in ABS

Kit supporto per fissaggio tavoli su orgatower H= 115 DV505 / Desk tables integration on orgatower H= 115 DV505 support kit

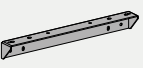
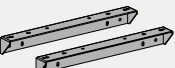

<p>505_ORG</p>  <p>812.KT.07.00 Supporto integrazione scrivania singola su orgatower H= 115 DV505 / Support for single desk integration on orgatower H= 115 DV505</p>	<p>505_ORG</p>  <p>812.KT.08.00 Coppia supporti per integrazione tavoli bench su orgatower H= 115 DV505 / Pair of supports for bench tables integration on orgatower H= 115 DV505</p>
---	--

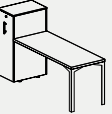
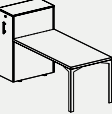
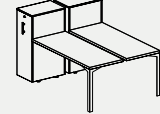
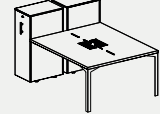
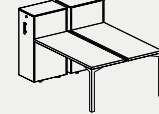
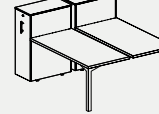
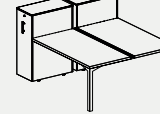
Composizioni con tavoli integrabili a orgatower H= 115 DV505 / Compositions with integrable desks on orgatower H= 115 DV505 **505_ORG**



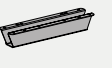

P 65 x H 75,5	P 80 x H 75,5	P 130 - 130,3 - 136,5 x H 75,5	P 136,5 x H 75,5	P 136,5 x H 75,5 B	P 160 - 160,3 - 166,5 x H 75,5	P 166,5 x H 75,5 B
						
L 160 -180	L 160 - 180 - 200	L 160 - 180	L 160 - 180	L 160 - 180	L 160 - 180	L 160 - 180

Note: Ordinare sempre il kit Cod. 812.KT.07.00 per i tavoli singoli e il kit Cod. 812.KT.08.00 per i tavoli bench / Always order the kit Cod. 812.KT.07.00 for single desk tables and the kit Cod. 812.KT.08.00 for bench tables. Ordinare a parte gli orgatower H= 115 e relativi accessori, consultare il listino DV505/Order the H= 115 orgatower and related accessories separately, see DV505 price list

Kit supporto per fissaggio tavoli su moduli tecnici (DV504) / Desk tables integration on technical modules (DV504)

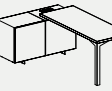
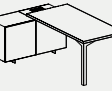
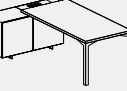
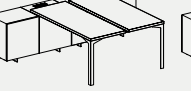
<p>504_MB</p>  <p>812.KT.09.00 Supporto integrazione scrivania singola su moduli tecnici (DV504) / Support for single desk integration on technical modules (DV504)</p>	<p>504_MB</p>  <p>812.KT.10.00 Coppia supporti per integrazione tavoli bench su moduli tecnici (DV504) / Pair of supports for bench tables integration on technical modules (DV504)</p>
---	--

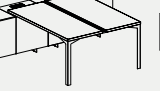
Composizioni con tavoli integrabili su moduli tecnici (DV504)/Compositions with integrable desks on technical modules (DV504) **504_MB**

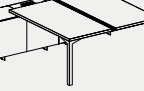

P 65 x H 75,5	P 80 x H 75,5	P 90 x H 75,5	P 130 - 130,3 - 136,5 x H 75,5	P 136,5 x H 75,5	P 136,5 x H 75,5 B	P 160 - 160,3 - 166,5 x H 75,5	P 166,5 x H 75,5 B
							
L 160 -180	L 160 - 180 - 200	L 180 - 200	L 160 - 180	L 160 - 180	L 160 - 180	L 160 - 180	L 160 - 180

Note: Ordinare sempre il kit Cod. 812.KT.09.00 per i tavoli singoli e il kit Cod. 812.KT.10.00 per i tavoli bench / Always order the kit Cod. 812.KT.09.00 for single desk tables and the kit Cod. 812.KT.10.00 for bench tables. Ordinare a parte i moduli tecnici e i relativi accessori, consultare il listino DV504/Order the technical modules and related accessories separately, see DV504 price list

Kit supporto per fissaggio tavoli su barra (DV504)/ Desk tables integration on bar (DV504)

<p>504_BR</p>  <p>812.KT.11.00 Supporto integrazione scrivania singola su barra (DV504) / Support for single desk integration on bar (DV504)</p>	<p>504_BR</p>  <p>812.KT.12.00 Coppia supporti per integrazione tavoli bench su barra (DV504) / Pair of supports for bench tables integration on bar (DV504)</p>
--	---

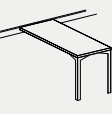
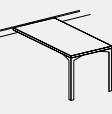
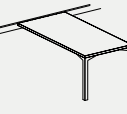
Composizioni con tavoli integrabili su barra (DV504)/Compositions with integrable desks on bar (DV504) **504_BR**

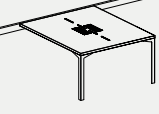
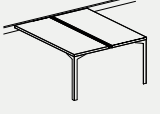
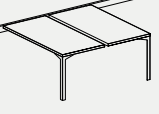
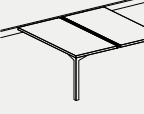

P 65 x H 75,5	P 80 x H 75,5	P 90 x H 75,5	P 130 - 130,3 - 136,5 x H 75,5	P 136,5 x H 75,5	P 136,5 x H 75,5 B	P 160 - 160,3 - 166,5 x H 75,5	P 166,5 x H 75,5 B
							
L 160 -180	L 160 - 180 - 200	L 180 - 200	L 160 - 180	L 160 - 180	L 160 - 180	L 160 - 180	L 160 - 180

Note: Ordinare sempre il kit Cod. 812.KT.11.00 per i tavoli singoli e il kit Cod. 812.KT.12.00 per i tavoli bench / Always order the kit Cod. 812.KT.11.00 for single desk tables and the kit Cod. 812.KT.12.00 for bench tables. Ordinare a parte la barra a muro e i relativi accessori, consultare il listino DV504/Order the wall bar and related accessories separately, see DV504 price list

Note:



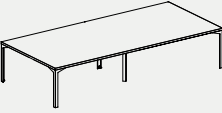
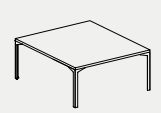
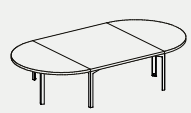
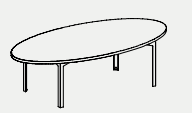
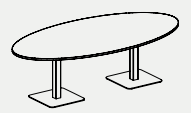
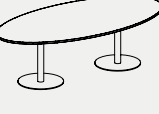

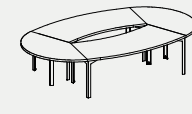
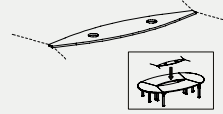

■ Prodotti non in pronta consegna. Per la disponibilità contattare l'ufficio commerciale/Items not in prompt delivery. Please contact the commercial department to check availability; **B** Con binario centrale/With central rail; **505_ORG** Fissaggio su orgatower DV505 / DV505 orgatower unit hooking; **504_MB** Fissaggio su moduli base DV504 / DV504 base modules hooking; **504_BR** Fissaggio su barra DV504 / DV504 metal bar hooking;

Tavolo riunioni/Conference tables

L 240 P 120 x H 75,5	L 140 P 140 x H 75,5	L 280 P 140 x H 75,5	L 250 P 125 x H 75,5	L 250 P 125 x H 75,5
				
812TR.40.24_	812TR.39.14_	812TR.75.28_	812TR.34.25_	812TR.05.25_
L 250 P 125 x H 75,5	H 75,5	H 75,5	L 365,7 P 215,5 x H 75,5	L 172,8 P 35 x H 3,8
				
812TR.04.25_	812TR.11.10_ ø 100 812TR.11.12_ ø 120	812TR.01.10_ ø 100 812TR.01.12_ ø 120	812TR.75.36_	812PR.75.17_

Note: Ordinare a parte due torrette elettrificate 300.AP.T_01 /Order two wired towers 300.AP.T_01 separately

Cassettiere/Pedestals

L 42 P 57 x H 55,5	L 32,2 P 54,2 x H 55,5	L 42,2 P 54,2 x H 55,5
		
550.CS.10.04_ Melaminico/Melamine	550.CS.20.04_ Melaminico/Melamine	550.CS.1M.03_ Metalliche/Metallic
		
550.CS.2M.03_ Metalliche/Metallic	550.CS.1M.04_ Metalliche - Vaschetta porta cancelleria inclusa/Metallic - Stationery tray included	550.CS.2M.04_ Metalliche - Vaschetta porta cancelleria inclusa/Metallic - Stationery tray included

Note: La finitura impiallacciato non è in pronta consegna. Per la disponibilità contattare l'ufficio commerciale. Per portacancelleria cassetti, vedi capitolo DV300-Accessori /Veneered finishes is not in prompt delivery. Please contact the commercial department to check availability. For stationary tray, see chapter DV300-Accessories.

Cassettiere sospese /Hanged pedestals

L 32,5 P 52 x H 14,5

812.CA.01.05 Sospesa metallica /Hanged metallic

Note: Per portacancelleria cassetti, vedi capitolo DV300-Accessori /For stationary tray, see chapter DV300-Accessories

Accessori su binari/Accessories on rail

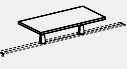
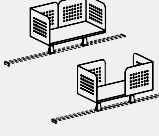
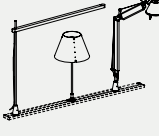
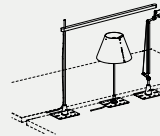
L 60 P 30 x H 1,8	L 60 P 30 x H 26,5		
			
812.AB.03.06	812.AB.04.06	812.AB.01.00	812.AB.01.01 Per bench P= 136,5 - 166,5 /For benches P= 136,5 - 166,5

Porta dox/ Top box

L 80 P 40 x H 40

300.AC.15.06 Metallico/Metallic

Modesty panels

P 1,8 x H35	<p>812.MP.01.12_ L 87</p> <p>812.MP.01.14_ L 107</p> <p>812.MP.01.16_ L 127</p> <p>812.MP.01.18_ L 147</p> <p>812.MP.01.20_ L 167</p> <p><small>Per tavoli/For desks</small></p>
-------------	--

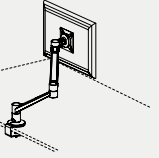
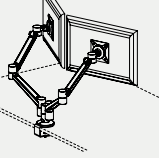
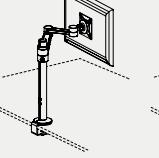
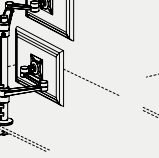
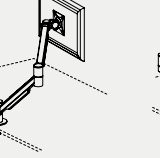
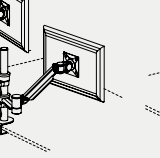
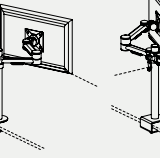
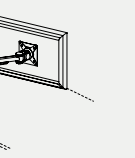
Bracci porta video/Arms for video support

							
300.AC.04.01 Braccio porta video mobile su piano /Dynamic arm for video support on deskbase	300.AC.04.02 Doppio braccio porta video mobile su piano/2 dynamic arms for video support on deskbase	300.AC.03.01 Braccio porta video statico su palo/Static arm for video support on deskbase	300.AC.03.02 Doppio braccio porta video statico su palo/2 static arms for video support on pole	300.AC.02.01 Braccio porta video mobile su piano /Dynamic arm for video support on deskbase	300.AC.02.02 Doppio braccio porta video mobile su piano/2 dynamic arms for video support on deskbase	300.AC.01.01 Braccio porta video statico su palo/Static arm for video support on pole	300.AC.01.02 Doppio braccio porta video statico su palo/2 static arms for video support on pole

Note:

■ Le dimensioni sono espresse in cm - consultare il listino prezzi per le caratteristiche tecniche, i codici degli articoli e delle finiture/Dimensions are stated in cm - for technical characteristics, article code numbers and finishing see price list; **■** Prodotti non in pronta consegna. Per la disponibilità contattare l'ufficio commerciale/Items not in prompt delivery. Please contact the commercial department to check availability; **■** Con serratura/With lock;

Frontal panels Sp. 0,8 - 1

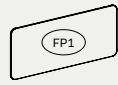
P 1 x H 39

 300.FP.06.06_L 64
 300.FP.06.07_L 79
 300.FP.06.09_L 99
 300.FP.06.11_L 119
 300.FP.06.13_L 139
 300.FP.06.15_L 159
 300.FP.06.17_L 179
 300.FP.06.19_L 199
 Melaminico/Melamine

P 0,8 x H 39

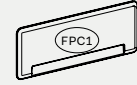
 300.FPV1.06_L 64
 300.FPV1.07_L 79
 300.FPV1.09_L 99
 300.FPV1.11_L 119
 300.FPV1.13_L 139
 300.FPV1.15_L 159
 300.FPV1.17_L 179
 300.FPV1.19_L 199
 Vetro/Glass

Frontal panel fonoassorbenti Sp. 3 / Acoustic frontals panels T. 3

P 3 x H 39

 300.FP.40.06_L 64
 300.FP.40.07_L 79
 300.FP.40.09_L 99
 300.FP.40.11_L 119
 300.FP.40.13_L 139
 300.FP.40.15_L 159
 300.FP.40.17_L 179
 Tessuto/Fabric

P 3 x H 59

 300.FP.50.13_L 139
 300.FP.50.15_L 159
 Tessuto/Fabric

Frontal panels H 65

P 1 x H 65

 300.FP.09.06_L 64
 300.FP.09.07_L 79
 300.FP.09.09_L 99
 300.FP.09.11_L 119
 300.FP.09.13_L 139
 300.FP.09.15_L 159
 300.FP.09.17_L 179
 300.FP.09.19_L 199
 Melaminico/Melamine

P 0,5 x H 65

 300.FP.69.06_L 64
 300.FP.69.11_L 119
 300.FP.69.13_L 139
 300.FP.69.15_L 159
 Plexiglass

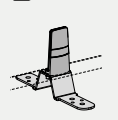
★ N.B.: Per i frontal con lunghezza maggiore o uguale ai 139 cm, ordinare 2 kit di supporti per frontal panel / Note: For frontal panels with a length greater than or equal to 139 cm, order 2 kits of clamps-supports for frontal panels

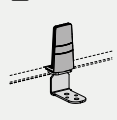
Staffe e supporti per frontal panels Sp. 0,5 - 0,8 - 1 - 3 / Brackets and clamps for frontal panels T. 0,5 - 0,8 - 1 - 3

(x2)  812.FP.91.01 Supporto per bench P=136,5 - 166,5 / Bracket for bench D= 136,5 - 166,5

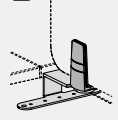
(x2)  812.FP.91.02 Supporto per bench P=130,3 - 160,3 / Bracket for bench D= 130,3 - 160,3

(x2)  812.FP.91.03 Supporto per piani per worktops

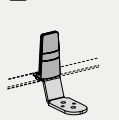
(x2)  812.FP.91.04 Supporto inclinato per piani / Inclined bracket for worktops

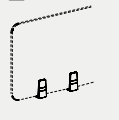
 300.FP.28.00 Per piani-binari / For worktops -tracks

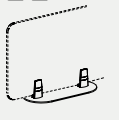
 300.FP.33.00 Free standing per piani / Free standing for worktops

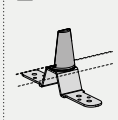
(x2)  812.FP.91.01 Supporto per bench P=136,5 - 166,5 / Bracket for bench D= 136,5 - 166,5

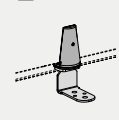

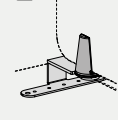

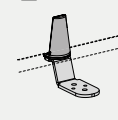

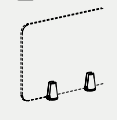
(x2)  812.FP.91.02 Supporto per bench P=130,3 - 160,3 / Bracket for bench D= 130,3 - 160,3

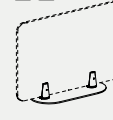
(x2)  812.FP.91.03 Supporto per piani per worktops

(x2)  812.FP.91.04 Supporto inclinato per piani / Inclined bracket for worktops

 300.FP.22.00 Per piani-binari / For worktops -track

 300.FP.33.00 Free standing per piani / Free standing for worktops

Per frontal panels / For frontal panels      

Accessori per frontal panels in melaminico / Accessories for melamine frontal panels

L 6,5 P 6,5 x H 8,5
 300.FA.01.01

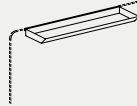
L 50 P 17 x H 3
 300.FA.02.05

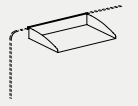
L 31 P 22 x H 5
 300.FA.04.03

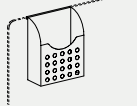
L 23 P 10 x H 29
 300.FA.06.02

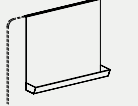
L 35 P 6,5 x H 30
 300.FA.08.03

Note: Il posizionamento degli accessori sui frontal panel in vetro prevede l'utilizzo di una guarnizione in PVC trasparente (Optional su richiesta) / Placement of accessories on glass front panel need the use of a transparent PVC gasket (Optional on request)
 Non utilizzabile su frontal panels in plexiglass e frontal panels in tessuto fonoassorbente / Not usable for plexiglass frontal panels and acoustic frontal panels

Frontal panel speciale / Special frontal panel

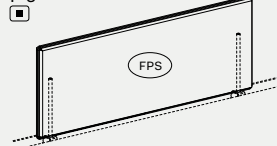
P 3

 300.FR.10.08 L 80 x H 30
 300.FR.60.14 L 140 x H 42,5

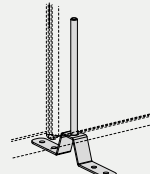
Supporti per frontal panel speciali / Bracket for special frontal panels

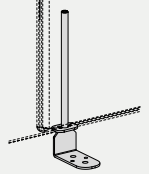
(x2)  812.FP.92.01 Supporto frontal speciali per bench P=136,5 - 166,5 / Special frontal panels bracket for bench D= 136,5 - 166,5

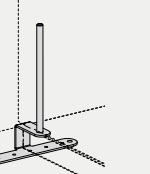
(x2)  812.FP.92.02 Supporto per frontal speciali per bench P=130,3 - 160,3 / Special frontal panels bracket for bench D= 130,3 - 160,3

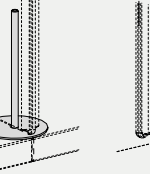
(x2)  812.FP.92.03 Supporto "flessibile" per frontal panel speciali / "Flexible" bracket for special frontal panels

(x2)  812.FP.92.05 Supporto "flessibile" per frontal panel speciali / "Flexible" bracket for special frontal panels

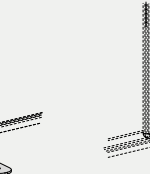
(x2)  812.FP.92.07 Supporto inclinato frontal panel speciali / Inclined bracket for special frontal panels

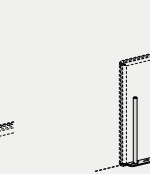
(x2)  812.FP.92.08 Supporto per binario frontal panel speciali / Bracket for central rail for special frontal panels

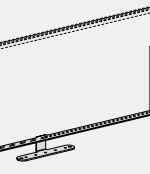
 812.FP.92.06 Supporto per frontal panel speciale L=80 / Bracket for special frontal panel W=80



Per frontal panels / For frontal panels 

Note:
 1 Le dimensioni sono espresse in cm - consultare il listino prezzi per le caratteristiche tecniche, i codici degli articoli e delle finiture / Dimensions are stated in cm - for technical characteristics, article code numbers and finishing see price list;
 2 Prodotti non in pronta consegna. Per la disponibilità contattare l'ufficio commerciale / Items not in prompt delivery. Please contact the commercial department to check availability;
 3 Vetro/Glass; 4 Plexiglass

5 Morsetti o supporti in ABS / ABS clamps
 6 Morsetti o supporti in ZAMA / Zamak clamps

Canalizzazione - Elettrificazione - Accessori / Wire management - Electrification - Accessories

 300.AP.T2.01 Ø 8

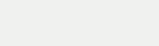
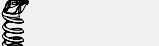
 812.AP.01.08 L 80
 812.AP.01.10 L 100
 812.AP.01.12 L 120
 812.AP.01.14 L 140
 812.AP.01.16 L 160

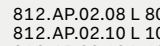
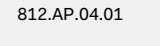
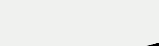
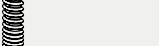
 812.AP.02.08 L 80
 812.AP.02.10 L 100
 812.AP.02.12 L 120
 812.AP.02.14 L 140

 812.AP.04.01

 812.AP.03.01



 300.AP.20.00

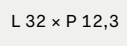

 300.AP.V1.00

 300.AP.F1.00

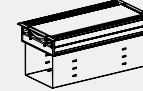
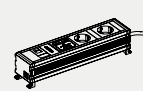
 300.AP.T8.01 Ø 8

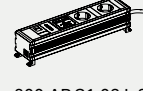

 L 32 x P 12,3

 300.AC.26.02 L 24,5
 300.AC.26.03 L 34,5
 300.AC.26.04 L 44,5

 300.AP.S1.02 L 20,5
 300.AP.S1.03 L 30
 300.AP.S1.04 L 42
 Per / For top access 300.AC.26...

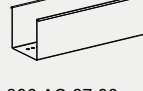
 300.AC.38.03_H 3

 300.AC.67.03
 Marsupio per top access
 300.AC.36... 300.AC.38...
 / Basket for top access
 300.AC.36... 300.AC.38...

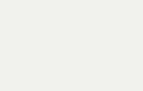
 300.AT.A6.02 L 21
 300.AT.A6.03 L 25,5
 300.AT.A6.04 L 39

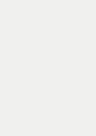
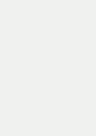
 300.APT4.01
 300.APT5.01 - UK
 300.APT6.01 - US

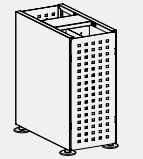
 300.AC.16.02

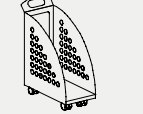
 300.AC.06.05

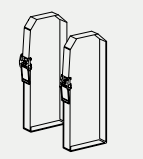
 812.AC.06.00
 Cinghie porta Cpu
 / Cpu holder straps

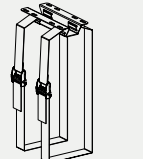
 812.AC.01.00
 Staffa e cinghie porta Cpu
 / Bracket and cpu holder straps

 300.AC.16.02

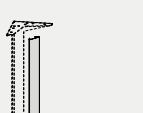
 300.AC.06.05

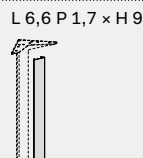
 812.AC.06.00
 Cinghie porta Cpu
 / Cpu holder straps

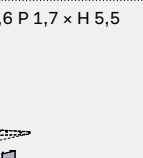
 812.AC.01.00
 Staffa e cinghie porta Cpu
 / Bracket and cpu holder straps

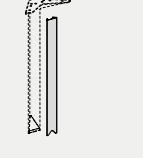
L 6,6 P 1,7 x H 63
 812.AP.08.00
 Carter gamba
 / Carter leg

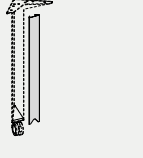
L 6,6 P 1,7 x H 59
 812.AP.08.03
 Carter gamba con ruota
 / Carter for leg with wheel

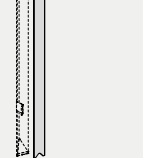
L 6,6 P 1,7 x H 94
 812.AP.08.05
 Carter gamba tavoli alti
 / Carter for high tables leg

L 6,6 P 1,7 x H 5,5
 812.AP.08.07
 Carter per supporto per mobile di servizio
 / Carter for service unit support

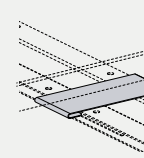
L 13 P 6,2 x H 0,5
 812.AC.07.01
 Carter per omega bench
 / Carter for bench's omega

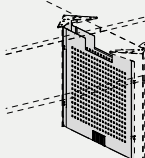
 812.GC.01.05
 Coppia carter per gamba intermedia
 P= 130 / 130,3 / 136,5 / 160 / 160,3 / 166,5
 / Pair of casings for middle leg
 D= 130 / 130,3 / 136,5 / 160 / 160,3 / 166,5

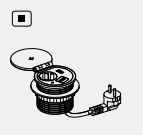
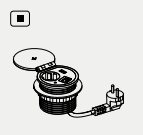
Ø 8
 300.AP.T8.11
 300.AP.T8.12 - UK
 300.AP.T8.13 - US

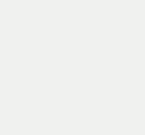
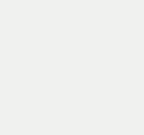
L 5 P 3 x H 5
 812.AC.08.01
 812.AC.08.01 - UK
 812.AC.08.01 - US
 Presa USB (solo ricarica)
 / USB Socket (only charge)

300.AP.T8.11
 300.AP.T8.12 - UK
 300.AP.T8.13 - US
 Tappo con 1 presa elettrica + USB (solo ricarica) + passacavo / Plug with 1 electrical socket + USB (only charge) + outlet lid

300.AP.T8.14
 300.AP.T8.15 - UK
 300.AP.T8.16 - US
 Tappo con 1 presa elettrica + USB (solo ricarica) + HDMI / Plug with 1 electrical socket + USB (only charge) + HDMI

300.AP.T8.17
 300.AP.T8.18 - UK
 300.AP.T8.19 - US
 Tappo con 1 presa elettrica + USB (solo ricarica) + RJ45 / Plug with 1 electrical socket + USB (only charge) + RJ45

300.AP.T8.20
 300.AP.T8.21 - UK
 300.AP.T8.22 - US
 Tappo con 1 presa elettrica + USB (solo ricarica) + USB dati / Plug with 1 electrical socket + USB (only charge) + USB data

Note:
 1 Le dimensioni sono espresse in cm - consultare il listino prezzi per le caratteristiche tecniche, i codici degli articoli e delle finiture / Dimensions are stated in cm - for technical characteristics, article code numbers and finishing see price list;
 2 Per la scelta dei contenitori e degli accessori vari, consultare il relativo listino o catalogo / To choose storage units and accessories, please check correspondent price list or catalogue;
 3 Fino ad esaurimento / Until exhaustion;
 4 Prodotti non in pronta consegna. Per la disponibilità contattare l'ufficio commerciale / Items not in prompt delivery. Please contact the commercial department to check availability;
 5 Articoli prodotti solo su richiesta / Items produced only on demand;